

Style:
 Overhead Braced
 Floor Mount
 Ceiling Mount
 Floor/Ceiling Mount

Material:
 Baked Enamel
 Plastic Laminate
 Solid Phenolic
 Solid Plastic
 Stainless Steel

Color: _____

Ship To: _____

City: _____

State: _____ Zip: _____

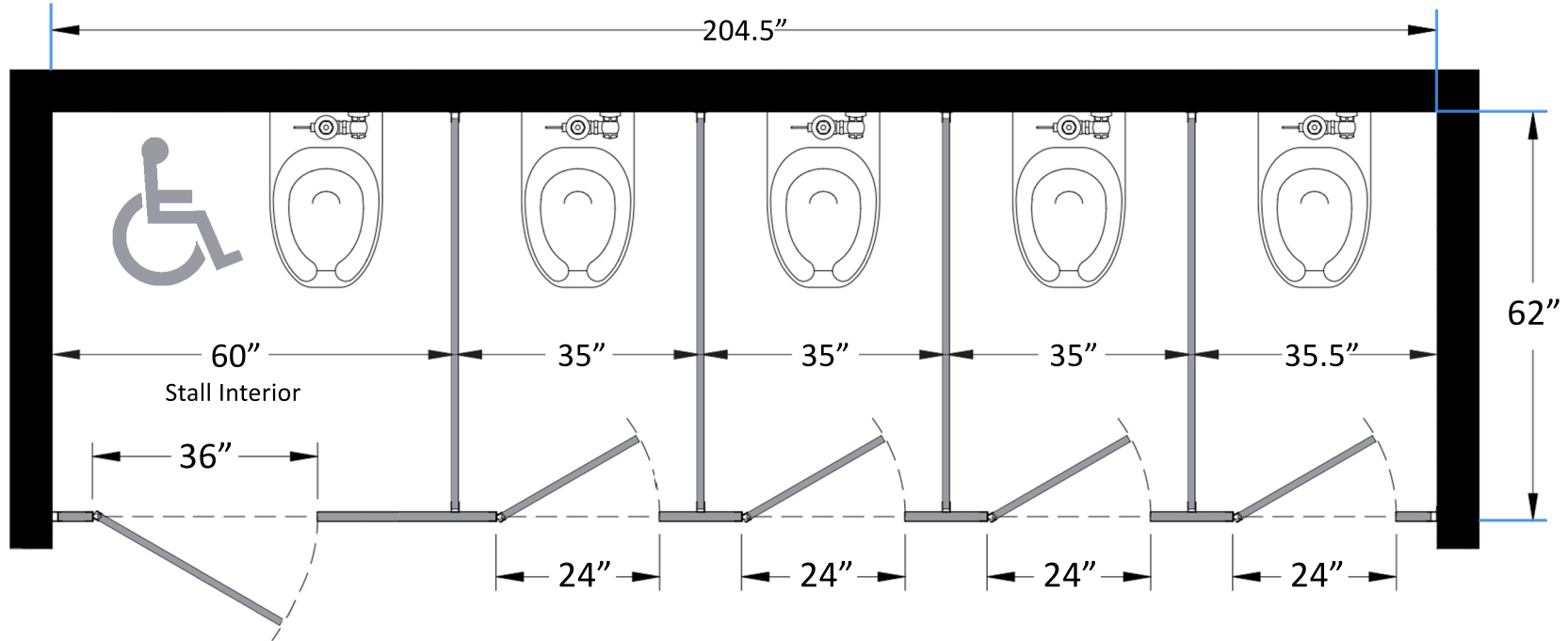

Bathroom Partitions - 5 Stalls Between Walls Left Hand ADA
SKU: BTW5LADA
Standard Dimensions

Harbor City Supply

Phone 443-279-0632 or 1-800-260-0907

1966 Greenspring Drive Suite 506, Timonium, Md. 21093

Fax 443-279-0015 sales@harborcitysupply.com